

Data Sheet



Article number: 202714B1225SW

Description: E+G Sensor holders - GN 271.4-B12-25-SW

Measures

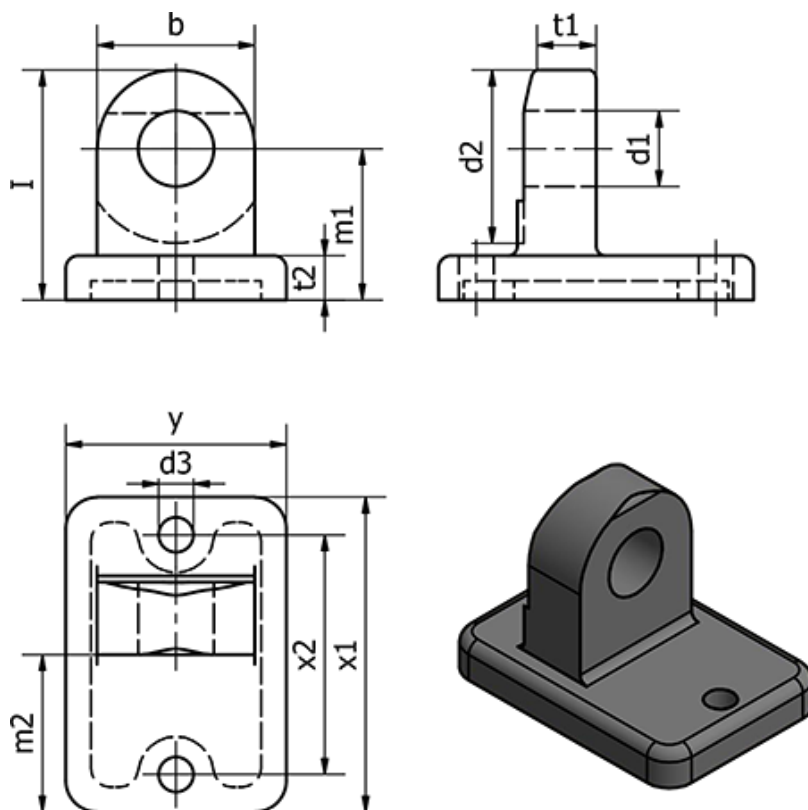

b	= 25	t2	= 7
d1	= B 12	Weight (g)	= 40
d2	= 30	x1	= 50
d3	= 5.5	x2	= 38
l	= 36.5	y	= 35
m1	= 24		
m2	= 25		
t1 -0,5	= 11.5		